

## Installation and Operating Instruction for B.E.G. - Occupancy detectors PD4-Master-TRIO-DALI-SM/-FC

### 1. Mounting preparations

Work on the 230V mains supply may only be carried out by qualified professionals or by instructed persons under the direction and supervision of qualified skilled electrical personnel in accordance with electrotechnical regulations.

Disconnect supply before installing!

When in Master/Slave mode of operation, the Master-appliance must always be installed at the location where there is least daylight.

### 2a. Installation of the LUXOMAT® PD4-M-TRIO-DALI-SM

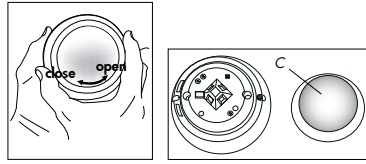

The detector must be installed on a solid and level surface. The circular cover ring must be removed prior to assembly. To do this, twist the lens (C) anticlockwise through approximately 5° and lift off.

Having connected up the wires in accordance with regulations, secure the detector with 2 screws. After installation replace the lens and lock (turn clockwise). Mains to be connected.

### 2b. Installation of the LUXOMAT® PD4-M-TRIO-DALI-FC

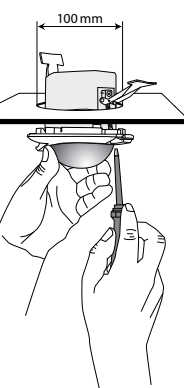

A circular opening of diameter 100 mm must be produced in the ceiling.

Having connected up the cables in accordance with regulations, the detector is inserted into the opening as shown and fixed into position with the retaining bracket using screws.

### 3. Hardware configuration

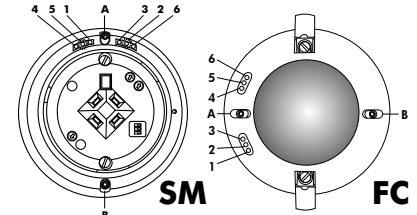

- A Light sensor 1 | B Light sensor 2
- 1 LED red OFF function
- 2 LED green too bright/too dark CDS 1
- 3 LED white semi-automatic DA 1/2
- 4 LED white semi-automatic DA 3
- 5 LED green too bright/too dark CDS 2
- 6 LED red motion indicator/walking test

### 4. Putting into operation of the remote control (optional)

Remote control  
LUXOMAT® IR-PD4-TRIO-DALI

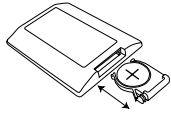

**1. Check Battery:**  
open battery compartment by pressing the plastic springs together and removing the battery-holder.

**Caution:**  
Settings with remote control supersede the settings by courtesy of potentiometers.

### 5. Position of potentiometer and DIP switch

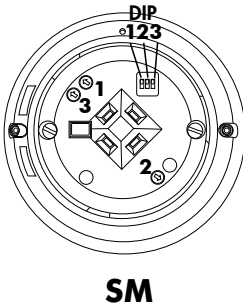

- DIP 1 HA / A
- DIP 2 Ini OFF/ON  
Lamps at start-up OFF/ON
- DIP 3 RESET

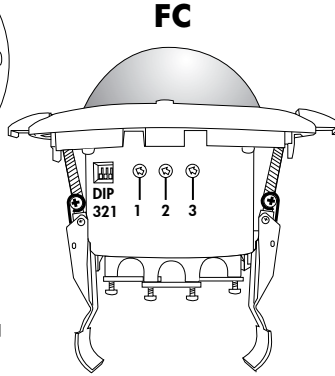

### 6. Putting into operation / Settings

#### Self test cycle

After an initial 60-second self-test cycle, the LUXOMAT® PD4-M-TRIO-DALI is ready for operation.



#### Potentiometer 3: Follow-up time for light control

The time can be set infinitely variably at between 1 and 60 minutes. The time-setting is valid for all three channels of the PD4-M-TRIO-DALI.

Symbol TEST: Test mode (Every movement switches on the light for a period of 2 second, switching it off for a period of 2 seconds after that regardless of the level of brightness.)



#### Potentiometer 2: Twilight-switch for light control

The switch-on value for the light can be set at between 40 and 1200 Lux. Using the rotary control, the luminance set points can be set as desired.

Symbol ☾: Night-time operation

Symbol ☀: Daytime/Night-time operation



#### Potentiometer 1: Orientation lighting

This rotary controller serves to determine the working time of the orientation lighting (fixed to 20%).

“ON” for permanent orientation lighting.

“OFF” for deactivation of orientation lighting.

### Option:

### Settings by remote control

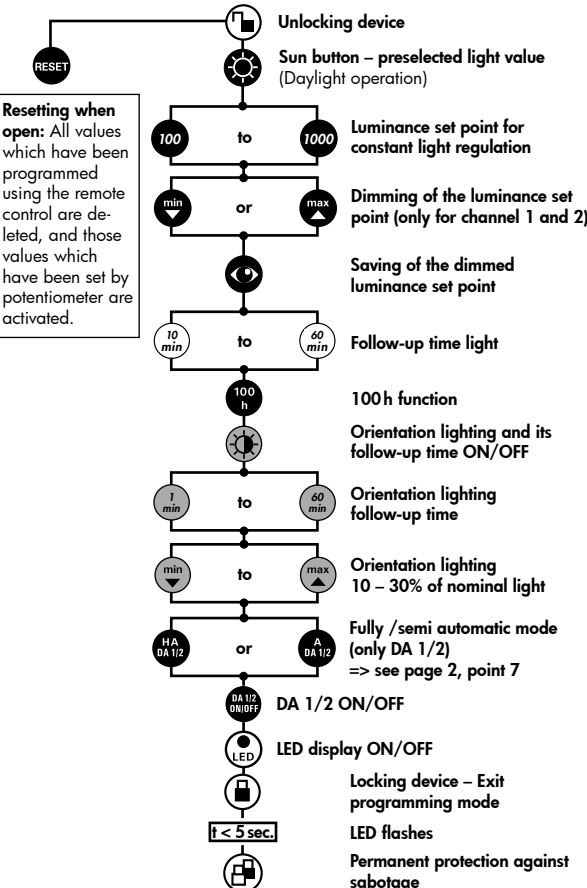

**Resetting when open:** All values which have been programmed using the remote control are deleted, and those values which have been set by potentiometer are activated.



Wall bracket for remote control IR-PD4-TRIO-DALI

### Explanation of the key functions



#### Dimming (=> see page 2, point 8)

The following approach will prove useful when setting a command value (example workplace): Place a luxmeter flat on the desk, then, using the remote control IR-PD4-TRIO-DALI, adjust the light up or down by pressing the keys max or min until the desired command value which best suits your requirements has been reached.



#### Saving of the through adjusted luminance set point



#### 100h function

to extend the life span – sums up automatically the burning time of 100% luminosity at the beginning up to 100 hours – only then can lights dim



#### Activate test mode - when locked

Deactivate test mode: press Reset



#### Resetting when locked

The lighting relay is switched off, i.e. opened and the follow-up times reset.



#### Permanent protection against sabotage when locked

This function blocks the unit permanently (all LEDs are flashing). All functions of the remote control are locked. Proceed to exit this mode: reset the hardware using DIP switch 3 or switch the supply voltage as follows:

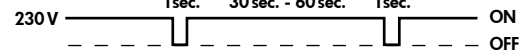

#### DA 1/2 ON/OFF when locked (=> see page 2, point 9)

The light will remain switched on/off for as long as movements are detected in the areas of coverage. Once the last movement has been detected, the light will remain on for the duration of the follow-up time as per setting. The appliance will then return independently to the mode selected (Fully or Semi-automatic).



#### Orientation lighting and its follow-up time ON/OFF

Note: During the orientation light phase, the constant light regulation is also active: if there is sufficient brightness, dimming occurs < 2V and, if applicable, the lighting is switched off.



#### Orientation lighting - Adjustment of the light intensity

The orientation lighting is adjustable in a span from 10 to 30% of the nominal light. Standard adjustment is 20%.

## 7. Fully / Semi automatic mode

(see DIP switch functions and IR-PD4-TRIO-DALI on page 1)

### Automatic operation

In this operating mode, the lighting switches automatically on and off for increased comfort, depending on presence and brightness.

### Semiautomatic operation

In this operating condition, in order to gain increased savings, the lighting is energized only after being manually switched on. Switch-off takes place automatically.

The semiautomatic mode basically behaves like the fully automatic one. However, the difference is that switching-on must always be carried out manually!

As many (closer-contact) buttons as desired can be wired in parallel on the "S" button input (ON/OFF DIM).

## 8. Manual Dimming

(for IR-PD4-TRIO-DALI functions see page 1)

You can dim manually by pressing the pushbutton for a long time (> 2 sec.). When the button is released, the current dimming value is retained. Upon renewed dimming, the dimming direction is reversed.

## 9. Manual Switching

You can switch the lighting on and off manually by pressing the pushbutton for a short time. It will stay on or off as long as people are detected plus the configured follow up time.

## 10. Range of Coverage

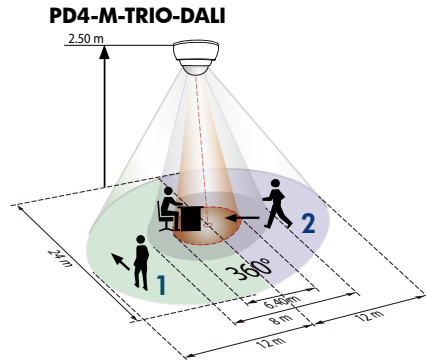

- 1 Walking across
- 2 Walking towards
- 3 Seated

## 11. Exclude sources of interference

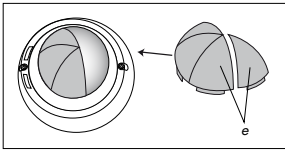

In case the sensing area of the LUXOMAT® PD4-M-TRIO-DALI is too large or areas are being covered that should not be monitored, the range can be reduced or limited through use of the enclosed masking clips (e).

## 12. Article / Part nr. / Accessory

Type	SM	FC	FM
PD4-M-TRIO-DALI (Master)	92750	92755	-
PD4-S (Slave)	92142	92254	92163

LUXOMAT® Remote control:  
IR-PD4-TRIO-DALI (incl. wall bracket) 92104

Accessory:  
Wire basket BSK 92199  
Wall bracket for remote control as replacement 92100  
SM-Socket IP44 for 92730 92386

## 13. Wiring diagram

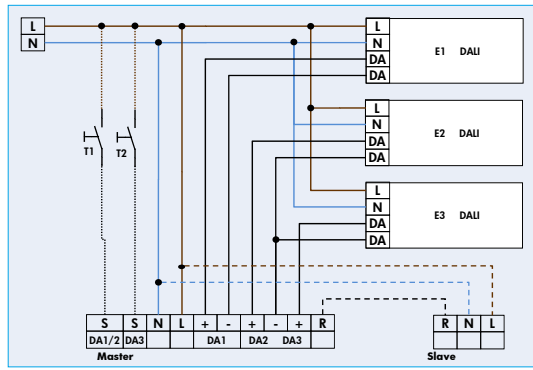

### optional

T1&2 = NO button for semi-automatic mode  
Slave for enlargement of detection area

## 14. PD4-M-TRIO-DALI - Connections

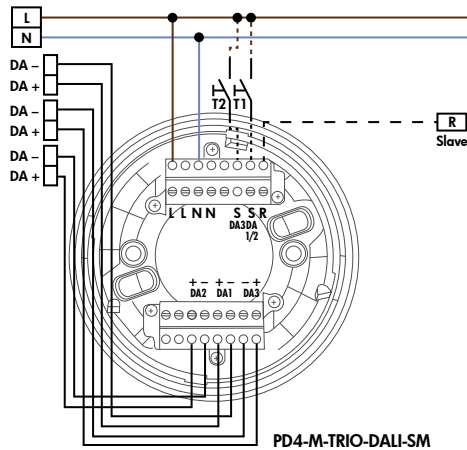
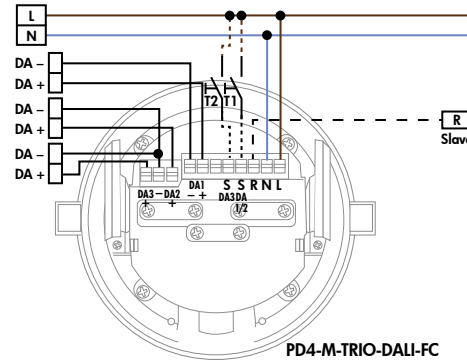

## 15. Technical data PD4-M-TRIO-DALI

Sensor and power supply in one case  
**Power supply:** 230V~ ±10%  
**Power consumption:** < 1W  
**Ambient temperature:** -25°C to +50°C  
**Degree of protection / class:** IP20 / II  
**Settings:** control dial, DIP switch and remote control  
**Light values-Remote control:** 100 - 1000 Lux  
**Extension of the detection area:** with Slaves  
**Area of coverage:** circular 360°  
**Range of coverage Ø H 2.50 m / T= 18°C:**  
 seated 6.40m / tangential 24 m / radial 8 m  
**Recommended height for mounting:** 2 - 3 m  
**Light measurement:** Mixed light, daylight + artificial light  
**Lux values-Potentiometer:** 10 - 1200 Lux  
 • DA 1/2 for light switching, light-controlled  
 • DA 3 for light switching (panel lighting), light-controlled  
**DA 1/2 DALI-BUS regular**  
**Max. numbers of connected EB's:**  
 each 25 for DA1 and DA2, 10 for DA3  
**Time-settings:** 1 - 60 min. / Test  
**Dimensions H x Ø [mm]** SM FC  
 PD4-M-TRIO-DALI 124 x 85 100 x 117  
**Visible portion when built into ceiling:** H 37 x Ø 117 mm

CE Declaration of Conformity: The product complies with the low voltage recommendation 2006/95/EC and the EMV recommendation 2004/108/EC.

**WE RECOMMEND THAT BEFORE DIMMING OF THE CONNECTED LIGHTS A 100 h BURN IN (T5 TUBES OR 80 HOURS FOR T8 TUBES) FUNCTION TAKES PLACE. THIS CAN BE IGNORED BY USING THE REMOTE CONTROL TO DEACTIVATE.**

**THE LIFESPAN OF THE LAMPS CAN BE REDUCED IF THE BURN IN DOES NOT TAKE PLACE.**

## 16. DIP switch functions

DIP switch	OFF	ON
1 (A)	Fully automatic channel DA 1/2 + DA3	Semi-automatic channel DA 1/2 + DA3
2 (B)	For mains ON / light ON	For mains ON / light OFF
3 (C)	Standard operation	RESET

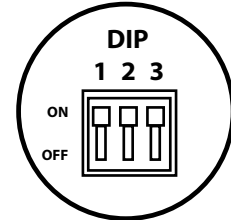

## 17. LED function displays

LED	Colour	Function	Display
6	red	Motion indicator	Lights up for motion detection
5	green	Light status indicator DA 1	flashes twice per sec.: - bright enough (light OFF)/ too bright (light ON) flashes once per sec.: - Delay time active
4	white	HA/VA DA 1/2	lights when semi-automatic
3	white	HA/VA DA 3	lights when semi-automatic
2	green	Light status indicator DA 2	flashes twice per sec.: - bright enough (light OFF)/ too bright (light ON) flashes once per sec.: - Delay time active
1	red	OFF-function	lights when the feature is activated, ie in the initialization phase the light is off
all LEDs		Acknowledgement	flashes once per sec.: - correct input flashes twice per sec.: - incorrect input flashes three times / once per sec.: - Reset when locked flashes three times / twice per sec.: - Double locked
all LEDs		Status	flashes shortly once per sec.: - Detector is double locked

## 18. Fault-finding

### Permanently flashing

Check whether DIP3 switch (RESET) is set to "ON"  
Reset to "OFF" if necessary